

**VMUG**

**user/con**

**The Netherlands**

# NSX-V vs. NSX-T

Matts Bos



# Spreker

## Matts Bos

- Infrastructure Consultant @RedLogic





17 vakidioten



Houten

## Accomplishments

## Partners



# Agenda

- Overlay
- Routing
- Loadbalancing
- Hypervisor
- Keuze NSX-V of NSX-T
  
- Migratie van V naar T



# Overlay

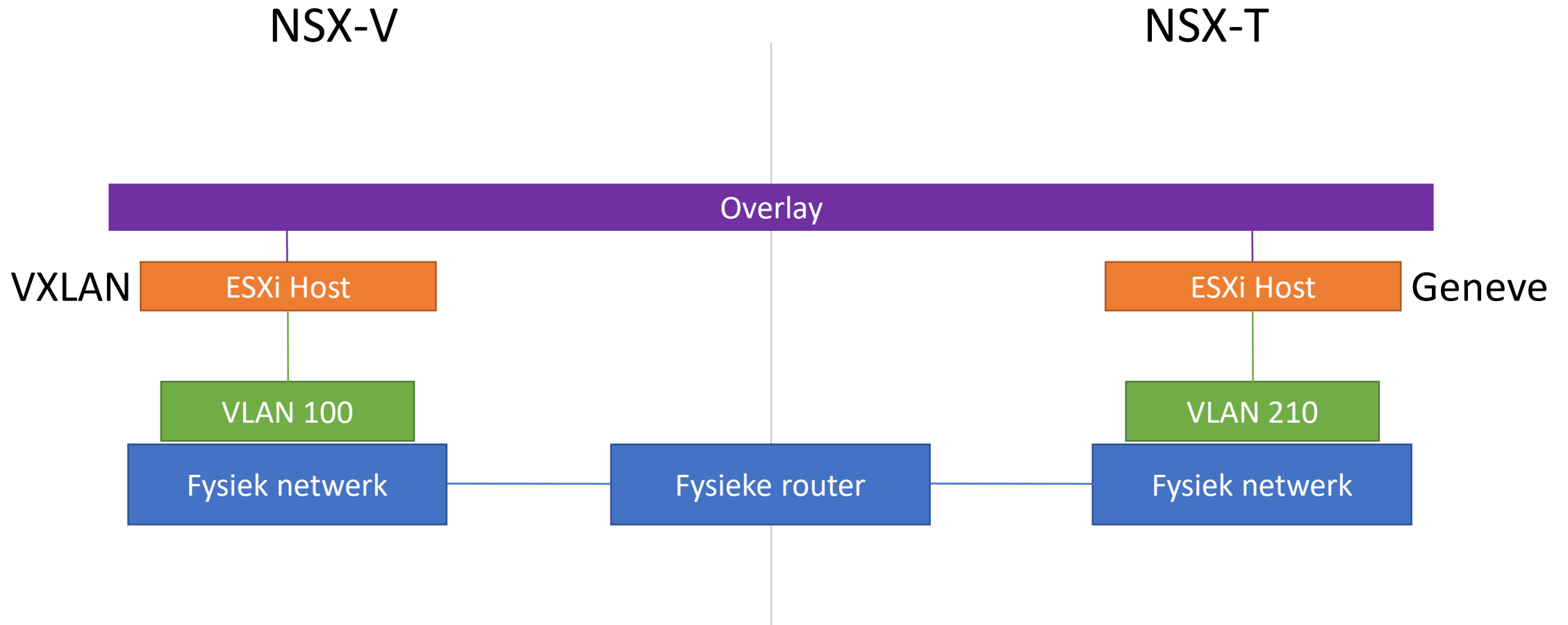

# Routing

## NSX-V



## NSX-T

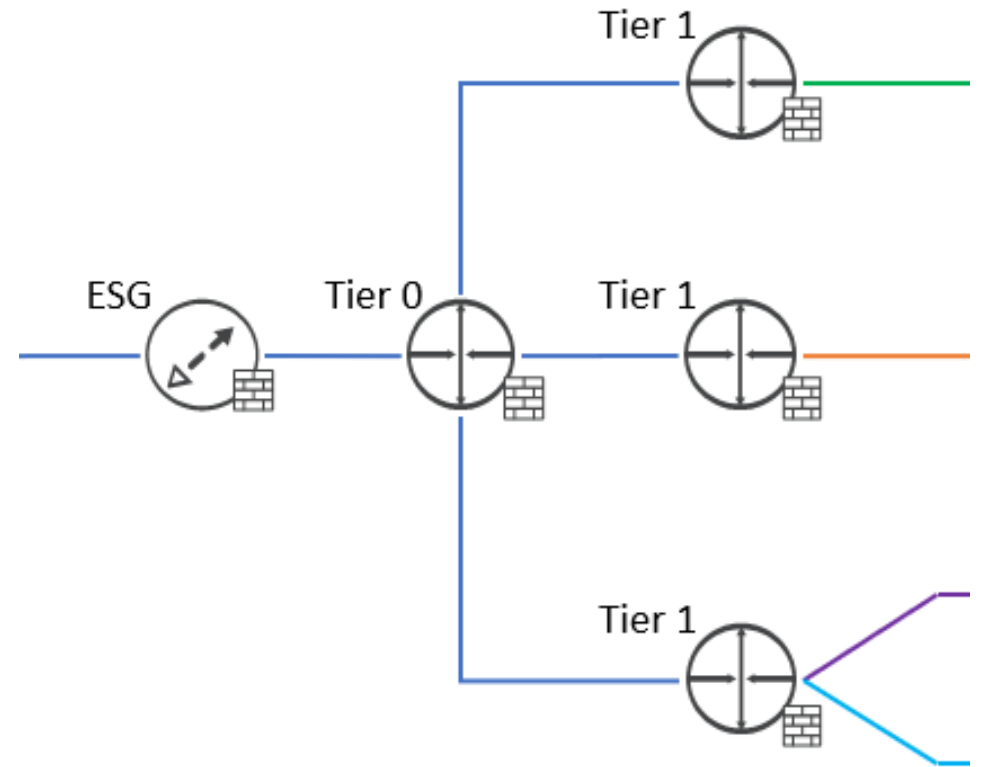

# Loadbalancing

NSX-V

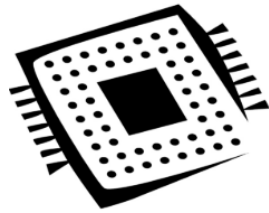

NSX-T

NGINX

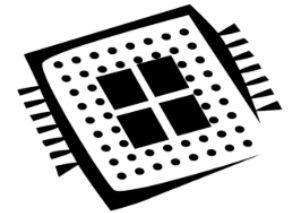



# Hypervisor

NSX-V



NSX-T



# Vergelijking

Onderdeel	NSX-V	NSX-T
Overlay	VXLAN	GENEVE
Routing	Single-Tier, OSPF/BGP	Multi-Tier, alleen BGP
Loadbalancing	HAProxy	NGINX
Integratie	1:1 met vCenter	Onafhankelijk
Containers	VMware Integrated Containers	Pivotal Container Services (PKS)
Hypervisor	ESXi	ESXi, KVM, Public Cloud
Edge	Virtueel	Virtueel, fysiek



# Voorbeeld situatie

- VMware omgeving.
- Private Cloud / On-Premises, ook in toekomst.
- Eis OSPF.
- Bewezen technologie.

## NSX-V



# Voorbeeld situatie

- VMware omgeving met KVM onderdelen.
- Volledig Cloud Native op Enterprise schaal (PKS).
- Schaalbaarheid m.b.v. Amazon AWS.

## NSX-T



# Voorbeeld situatie

- Bestaande VMware NSX-V omgeving.
- NSX-V behouden.
- Volledig Cloud Native op Enterprise schaal (PKS).

## NSX-V & NSX-T

# Migratie van NSX-V naar NSX-T

- Uitgangspunten
- Mogelijkheden



# Greenfield migratie

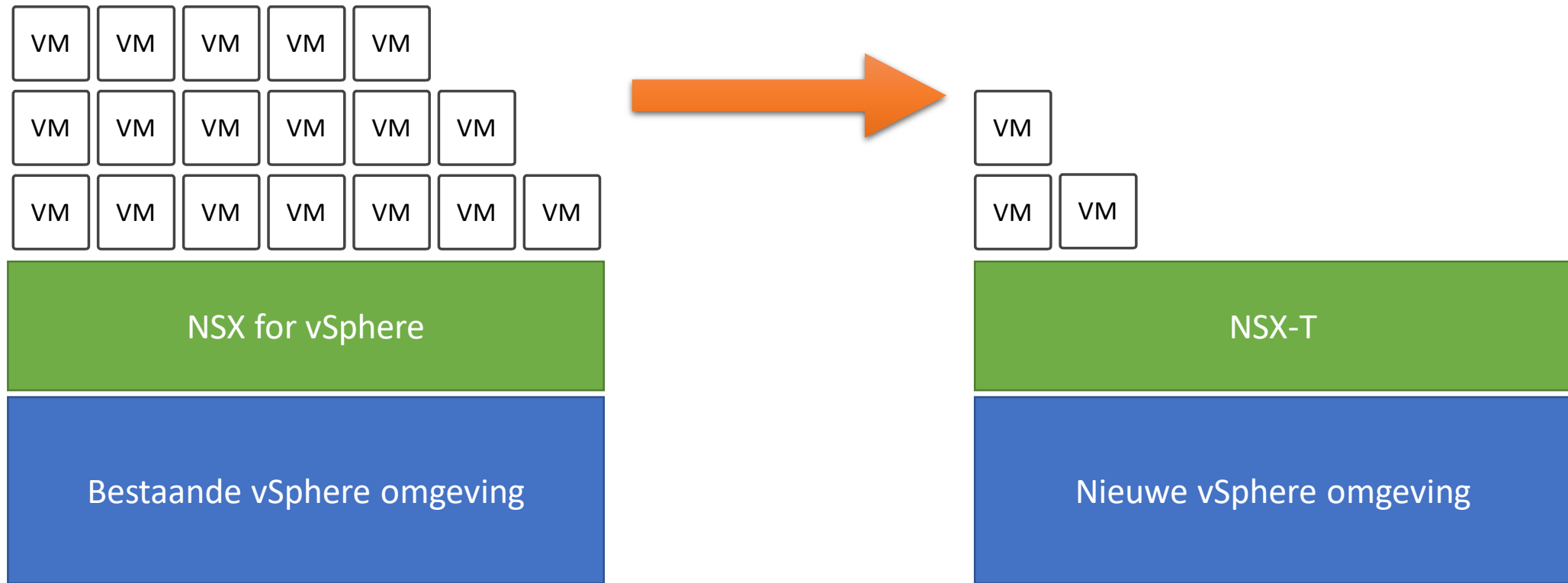

# Brownfield migratie: Splitsen

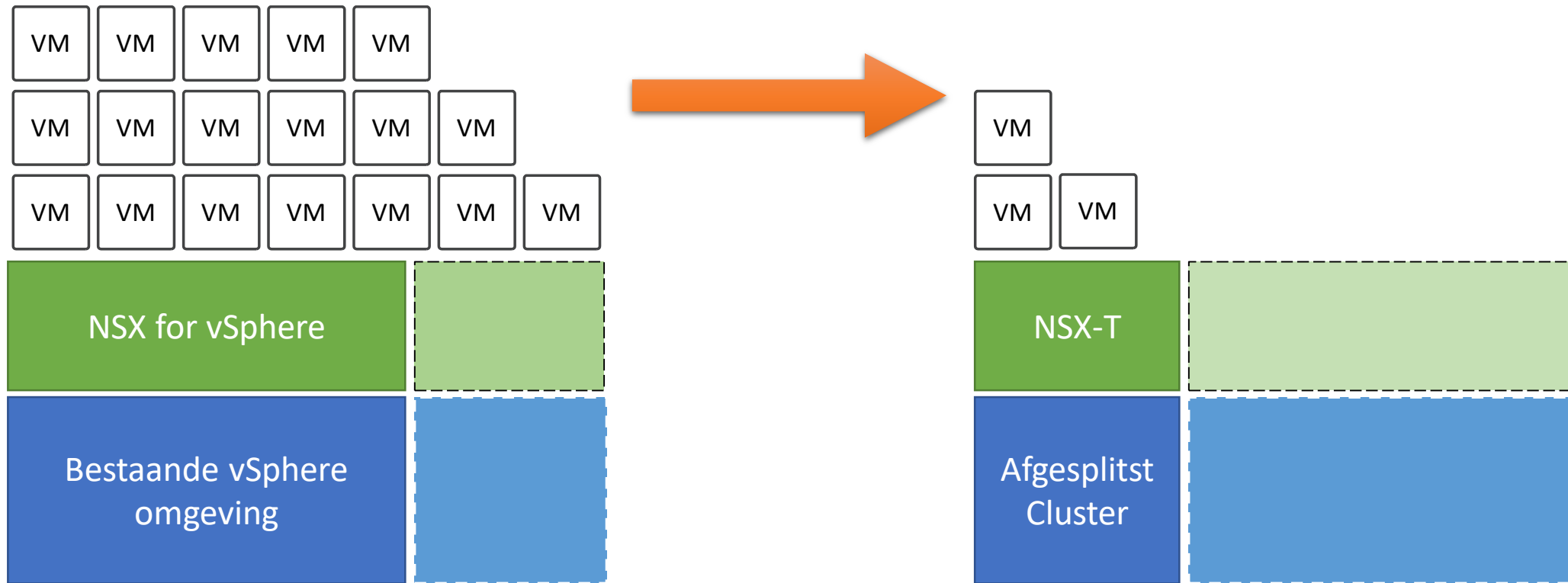



# Brownfield migratie: Vervangen

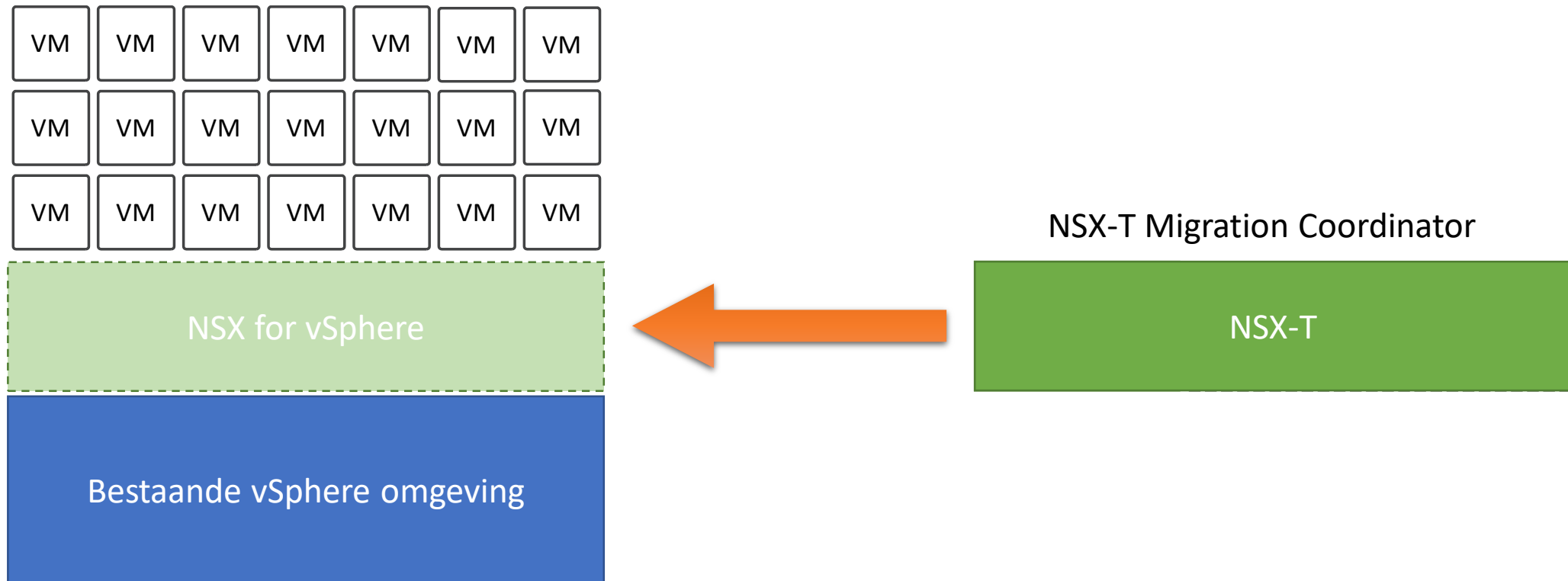



Vragen?

[matts.bos@redlogic.nl](mailto:matts.bos@redlogic.nl)

VMUG  
user/con